

CONTINUOUS HINGE JAMB DETAIL

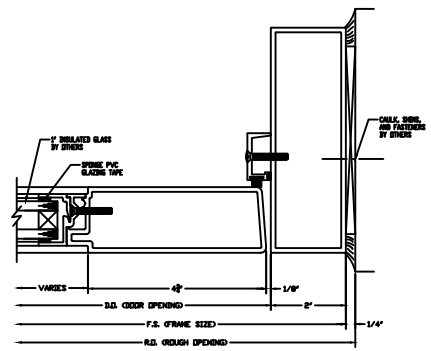

LOCK JAMB DETAIL

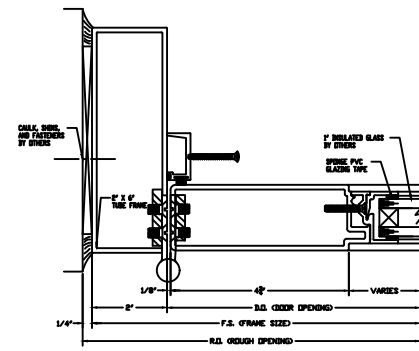

BUTT HINGE DETAIL

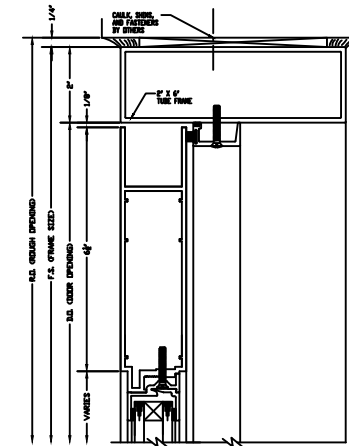

HEAD DETAIL

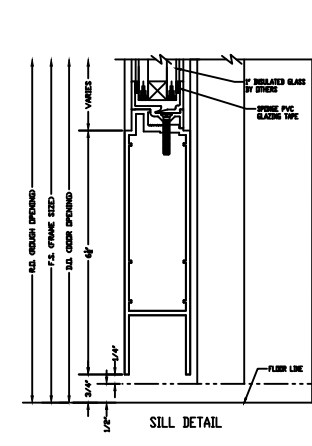

SILL DETAIL

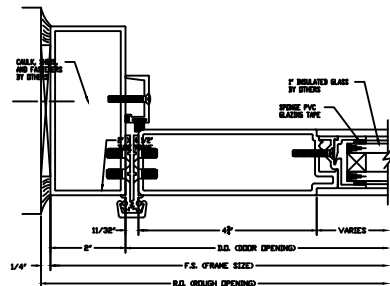

CONTINUOUS HINGE JAMB DETAIL

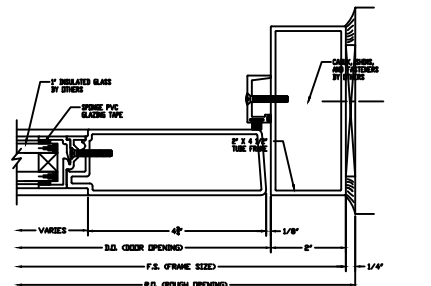

LOCK JAMB DETAIL

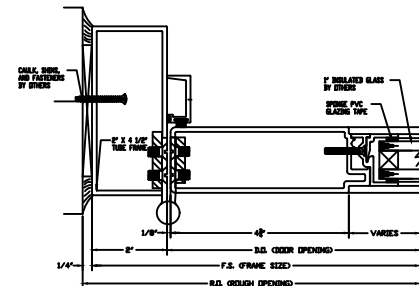

BUTT HINGE DETAIL

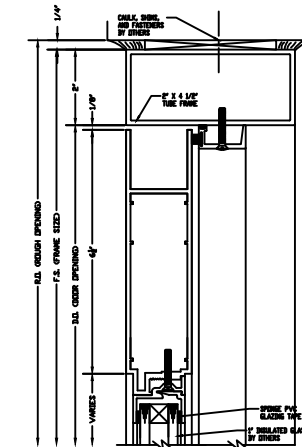

HEAD DETAIL

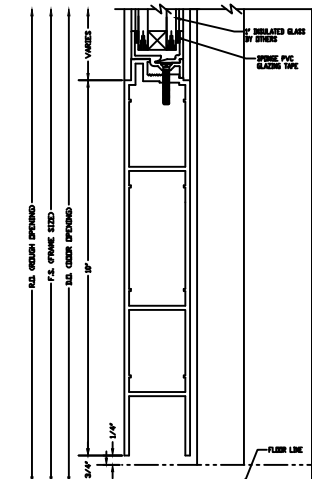

SILL DETAIL

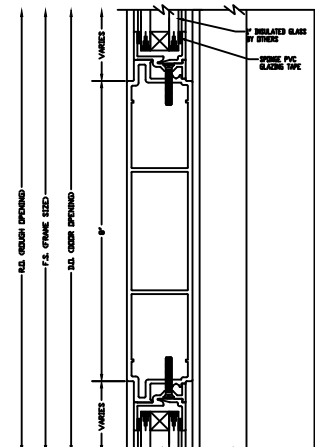

MID-RAIL DETAIL

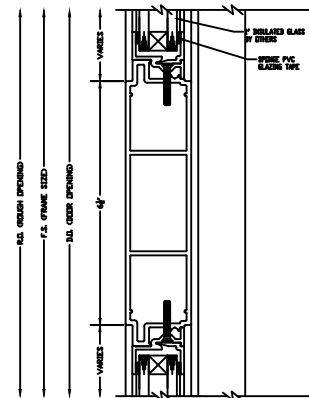

MID-RAIL DETAIL

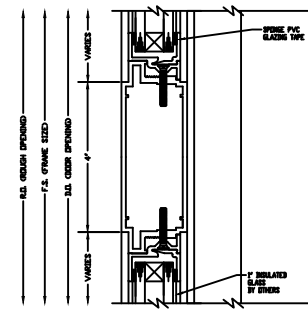

MID-RAIL DETAIL

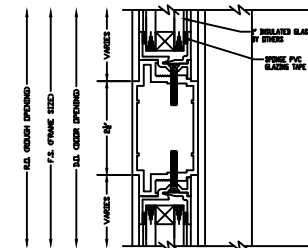

MID-RAIL DETAIL

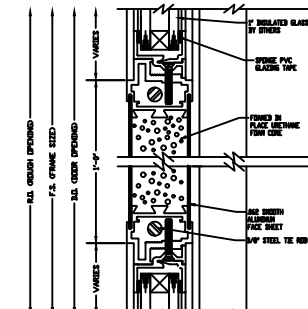

MID-PANEL DETAIL

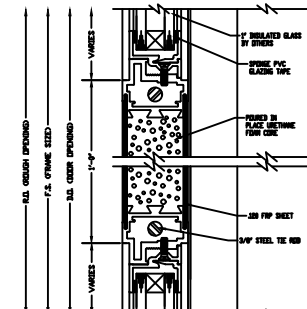

MID-PANEL DETAIL

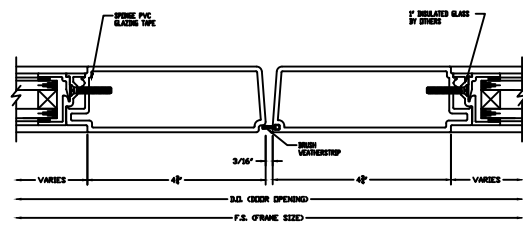

STANDARD MEETING STILES DETAIL

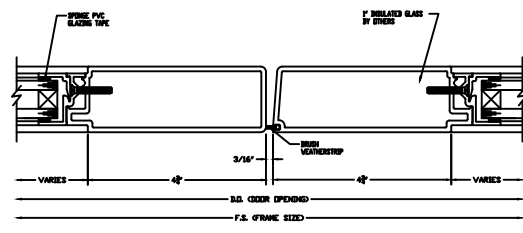

LOCKSET MEETING STILES DETAIL

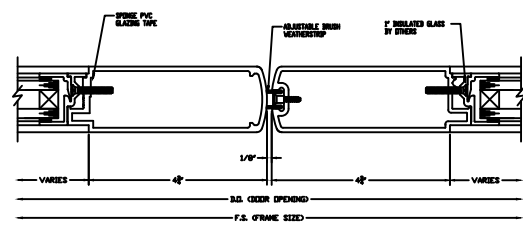

OPTIONAL MEETING STILES DETAIL

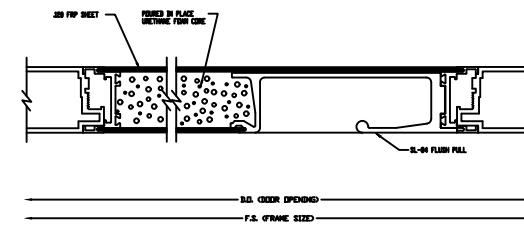

MID-PANEL DETAIL

		SPECIAL-LITE, INC. 860 South Williams Street P.O. BOX 6 DECATUR, MI 48045 WWW.SPECIAL-LITE.COM	
		DRAWN BY: JMM REVISION:	SL-15 WIDE STILE MONUMENTAL (1" GLAZING)
A 4/3/17 C B D	DATE: 4/3/2017	SHEET NO. 1 OF 2	FILE: SL15DETAILS.dwg

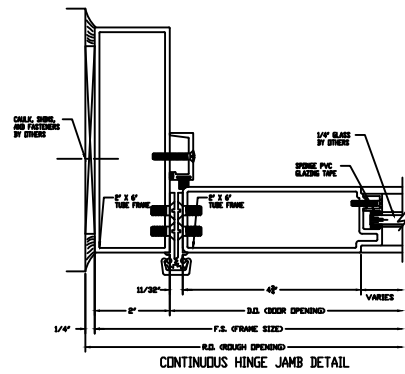

CONTINUOUS HINGE JAMB DETAIL

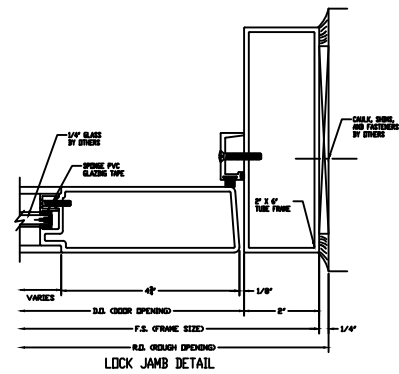

LOCK JAMB DETAIL

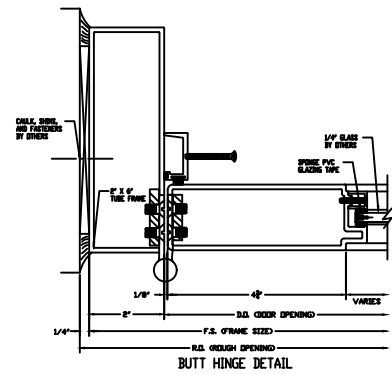

BUTT HINGE DETAIL

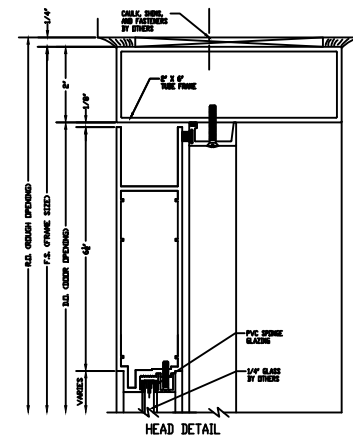

HEAD DETAIL

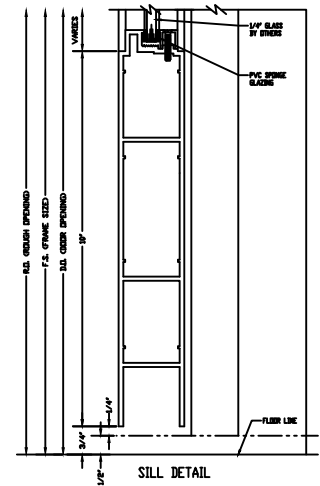

SILL DETAIL

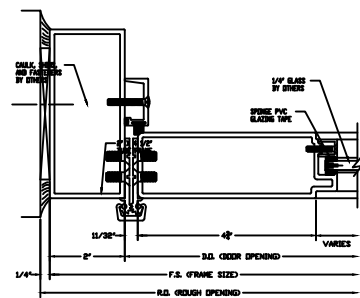

CONTINUOUS HINGE JAMB DETAIL

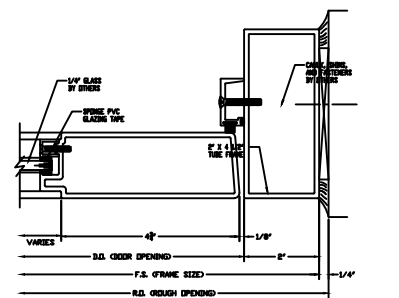

LOCK JAMB DETAIL

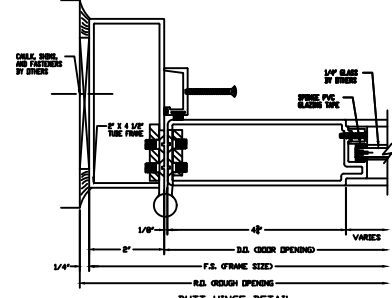

BUTT HINGE DETAIL

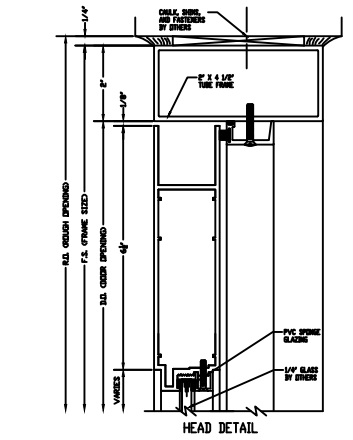

HEAD DETAIL

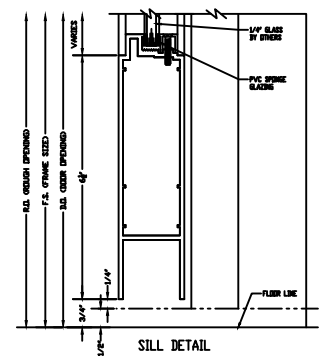

SILL DETAIL

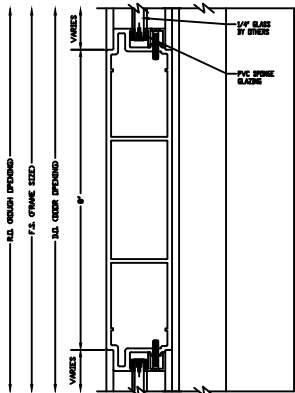

MID-RAIL DETAIL

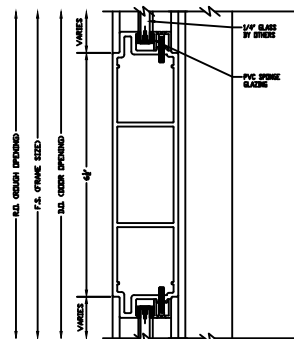

MID-RAIL DETAIL

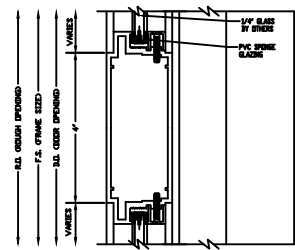

MID-RAIL DETAIL

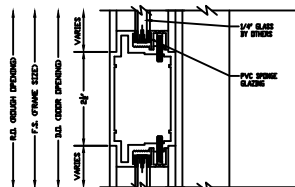

MID-RAIL DETAIL

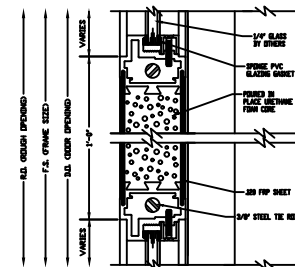

MID-PANEL DETAIL

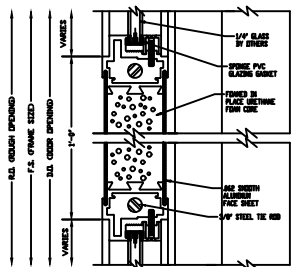

MID-PANEL DETAIL

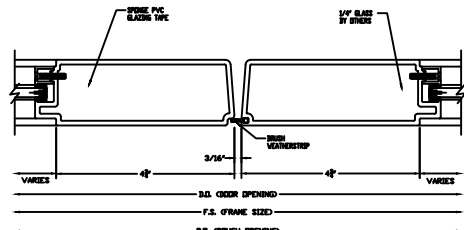

STANDARD MEETING STILES DETAIL

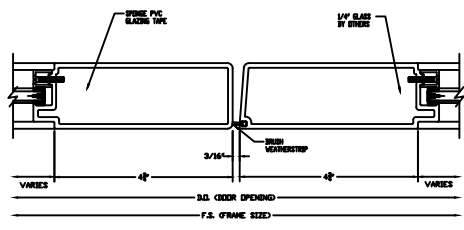

LOCKSET MEETING STILES DETAIL

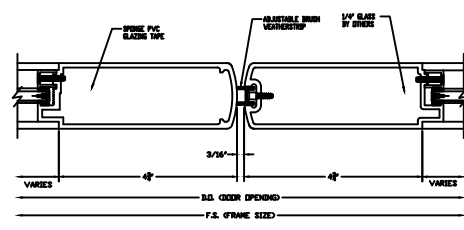

OPTIONAL MEETING STILES DETAIL

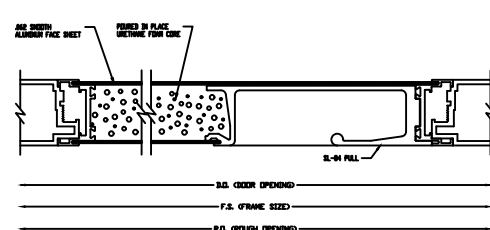

MID-PANEL DETAIL

		SPECIAL-LITE, INC. 860 South Williams Street P.O. BOX 6 DECATUR, MI 48045 WWW.SPECIAL-LITE.COM	
		DRAWN BY: JMM REVISION:	SL-15 WIDE STILE MONUMENTAL (1/4" GLAZING)
A 4/3/17 C B D	DATE: 4/3/2017	SHEET NO. 2 OF 2	FILE: SL15DETAILS.dwg