

CONTINUOUS HINGE JAMB DETAIL

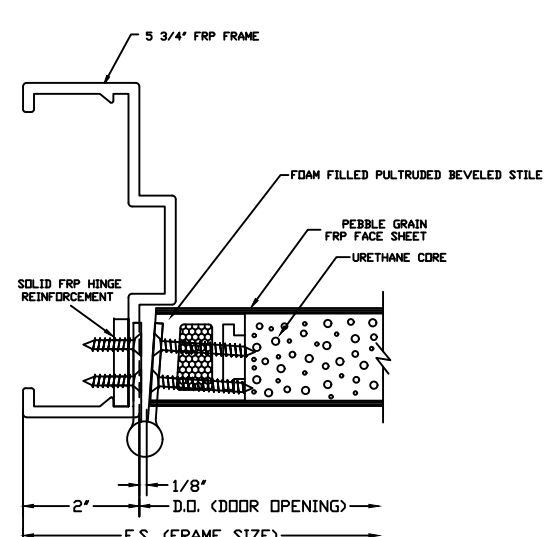

BUTT HINGE JAMB DETAIL

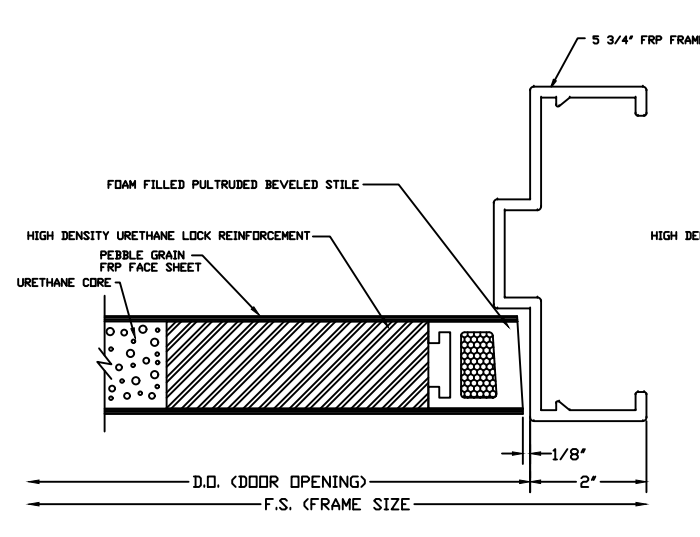

LOCK JAMB DETAIL

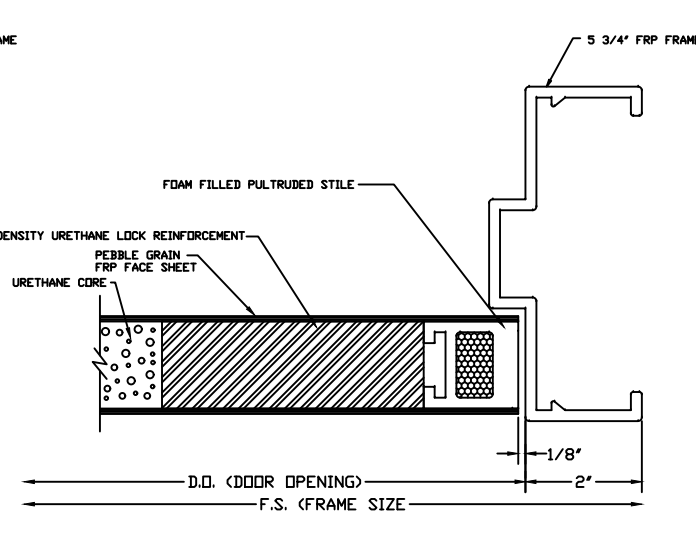

LOCK JAMB DETAIL (OPTIONAL SQUARE STILE)

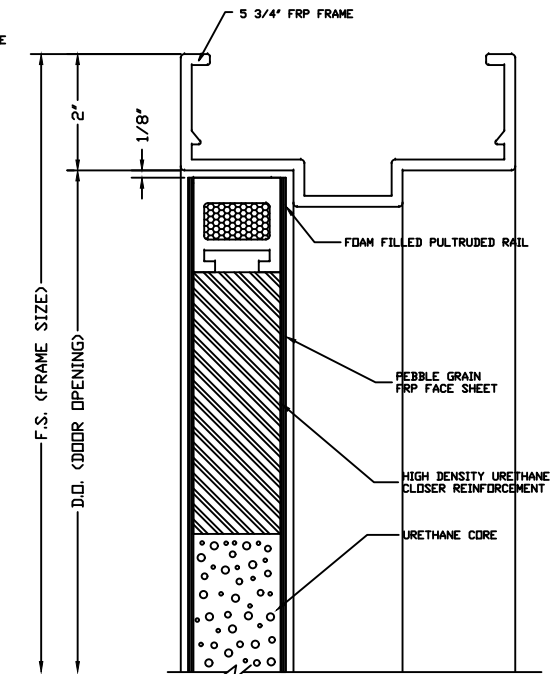

HEAD DETAIL

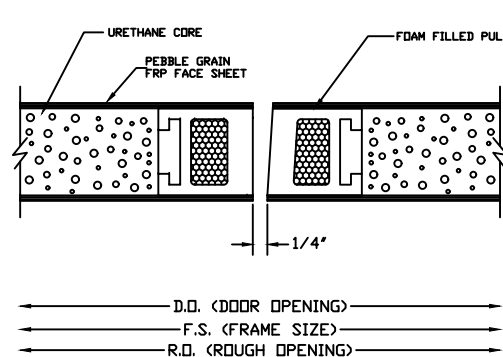

MEETING STILES (STANDARD)

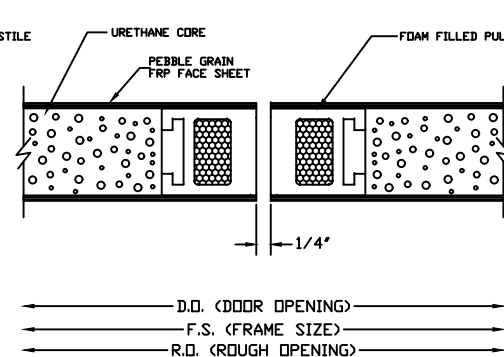

MEETING STILES OPTIONAL SQUARE STILES

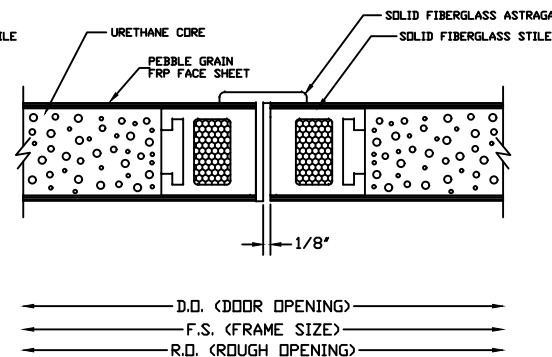

MEETING STILES WITH OPTIONAL ASTRAGAL

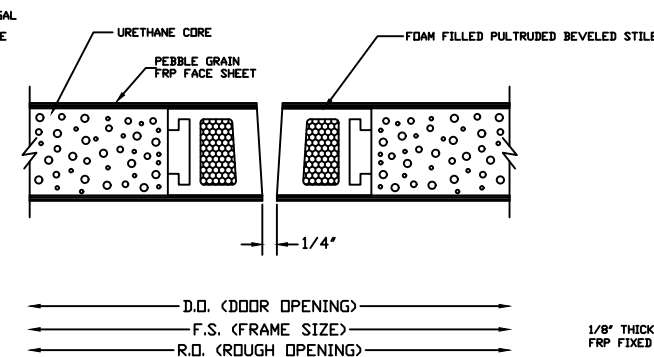

MEETING STILES WITH OPTIONAL DUAL BEVELED STILES

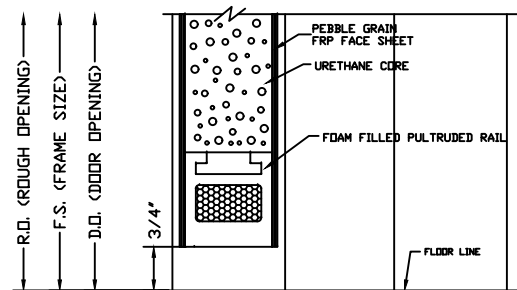

SILL DETAIL

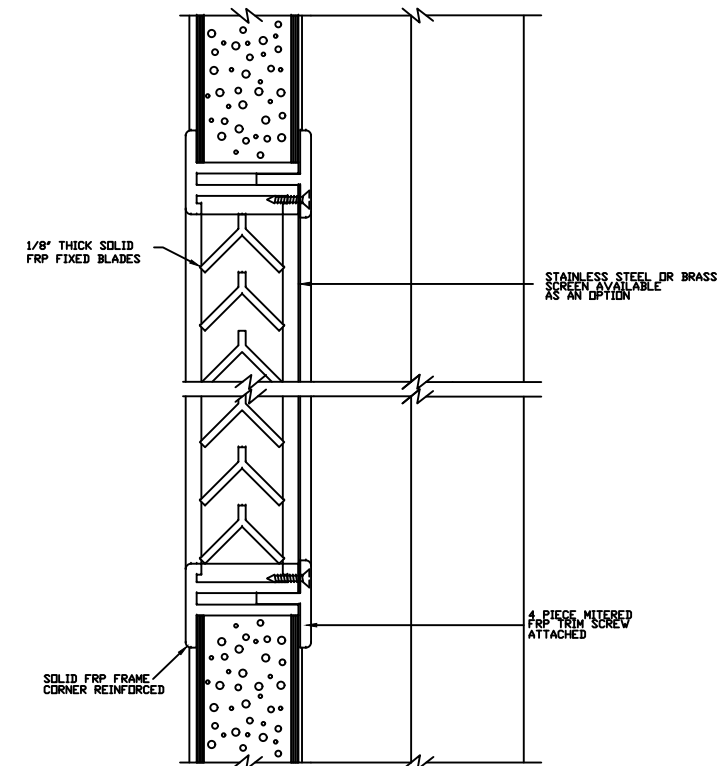

LOUVER WITH INSECT SCREEN DETAIL

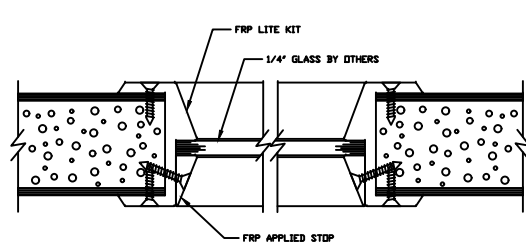

1/4" GLASS VISION LITE KIT DETAIL

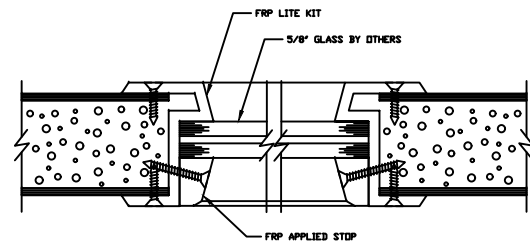

5/8" GLASS VISION LITE KIT DETAIL

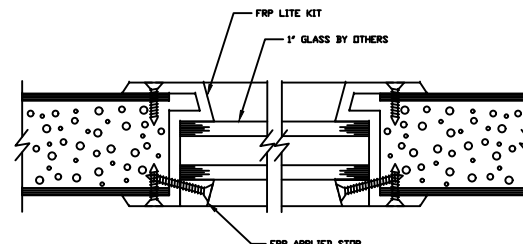

1" GLASS VISION LITE KIT DETAIL

		SPECIAL-LITE, INC. 860 South Williams Street P.O. BOX 6 DECATUR, MI 49045 WWW.SPECIAL-LITE.COM	
DRAWN BY: JMM REVISION D 6/27/17 F 7/20/17 E 6/28/17 G	AF-217 ALL FIBERGLASS COMPOSITE PEBBLE GRAIN DOOR DATE: 7/20/2017	SHEET NO. 1 OF 1	FILE: AF217DETAILS.dwg