

CONTINUOUS HINGE JAMB DETAIL

LOCK JAMB DETAIL

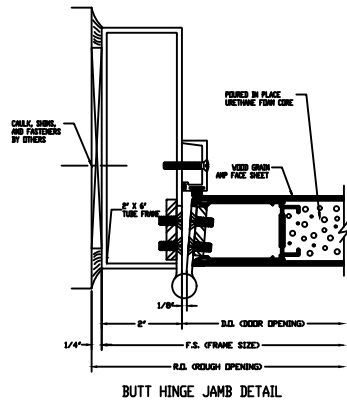

BUTT HINGE JAMB DETAIL

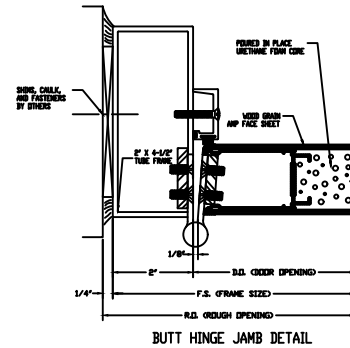

BUTT HINGE JAMB DETAIL

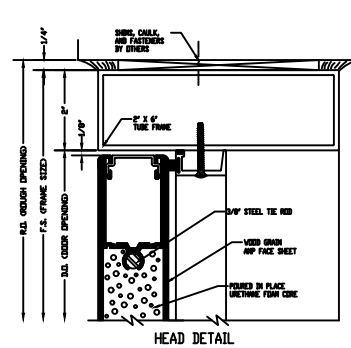

HEAD DETAIL

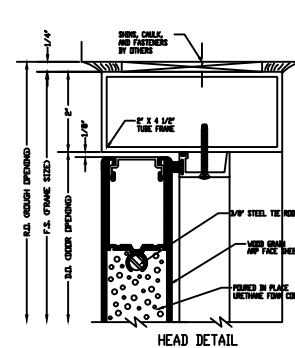

HEAD DETAIL

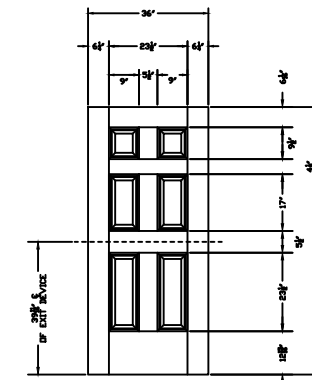

PATTERN 336A
MIN= 3'- 0" x 6'- 8"
MAX= 3'- 6" x 7'- 4"

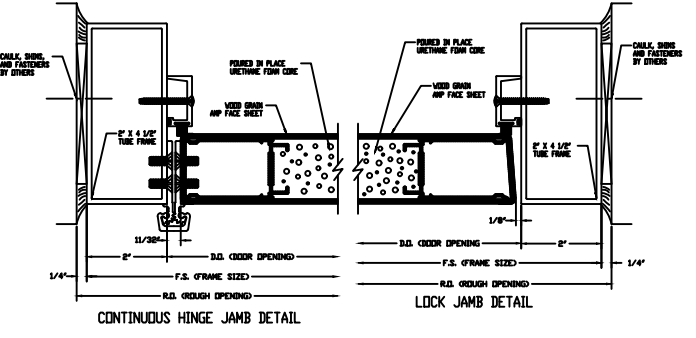
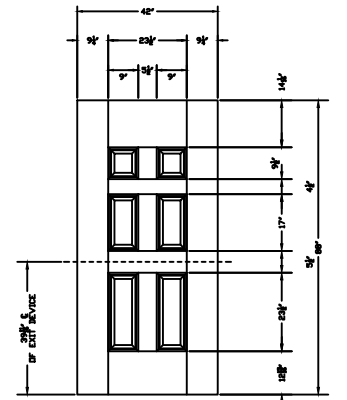

CONTINUOUS HINGE JAMB DETAIL

LOCK JAMB DETAIL

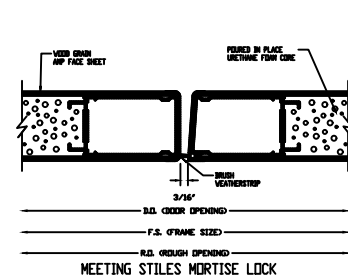

MEETING STILES MORTISE LOCK

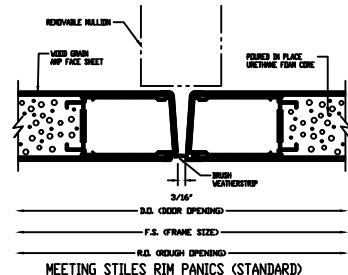

MEETING STILES RIM PANICS (STANDARD)

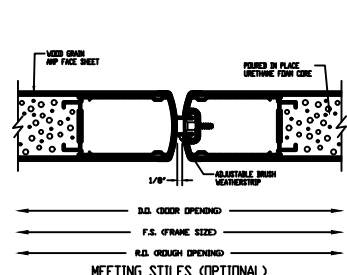

MEETING STILES (OPTIONAL)

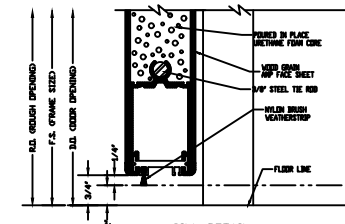

SILL DETAIL

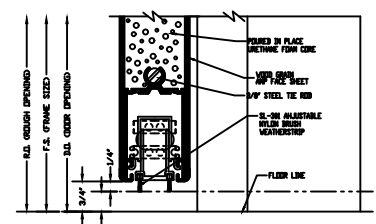

SILL DETAIL (OPTIONAL)

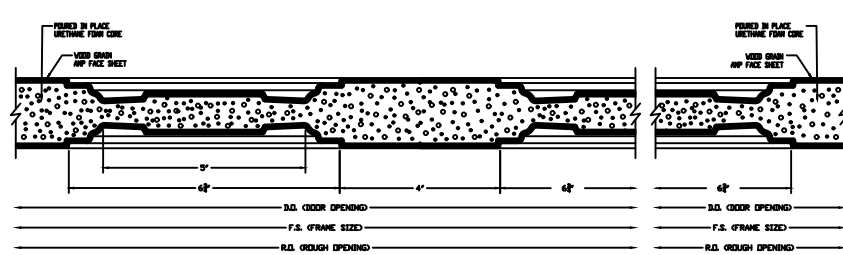

RAISED PANEL HORIZONTAL DETAIL

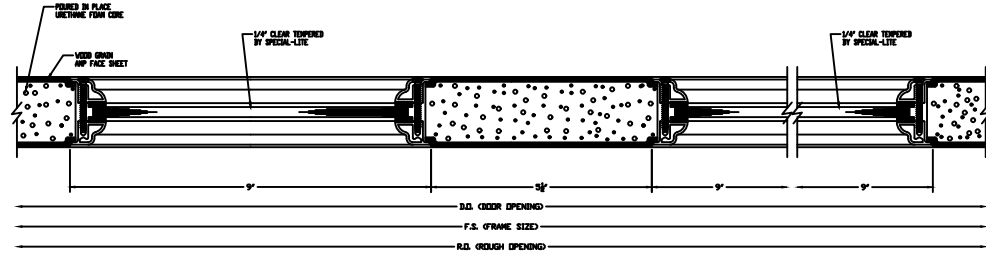

OPTIONAL 1/4" GLAZING HORIZONTAL DETAIL

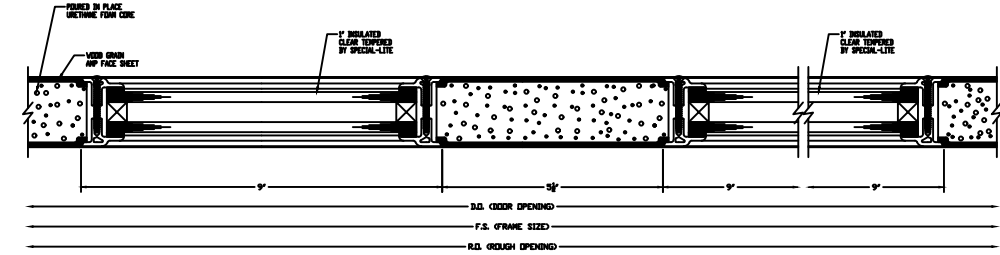

OPTIONAL 1" GLAZING HORIZONTAL DETAIL

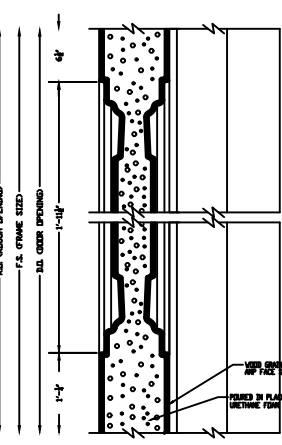

RAISED BOTTOM PANEL DETAIL

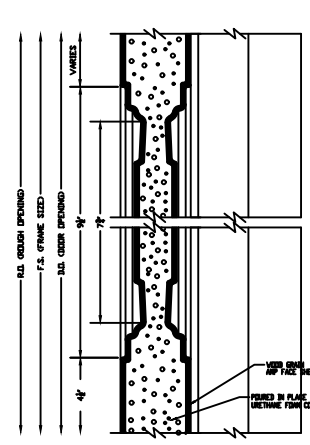

RAISED TOP-PANEL DETAIL

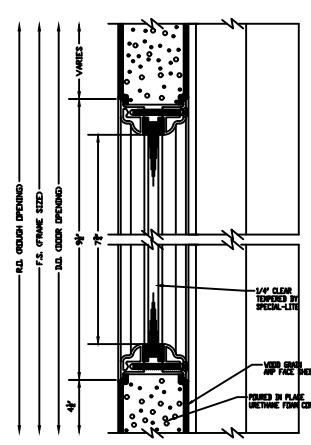

OPTIONAL TOP 1/4" GLAZING DETAIL

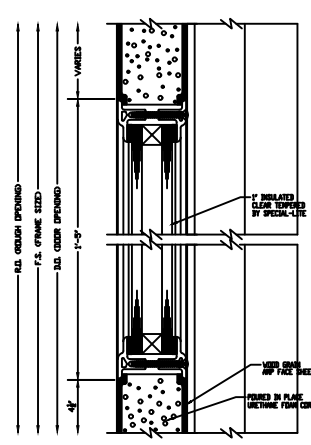

OPTIONAL TOP 1" GLAZING DETAIL

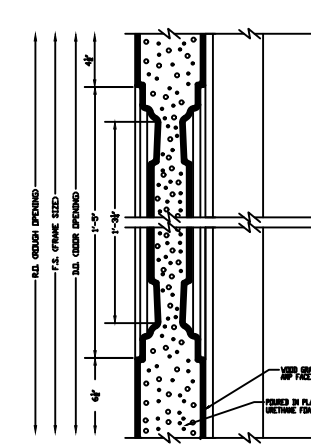

RAISED MID-PANEL DETAIL

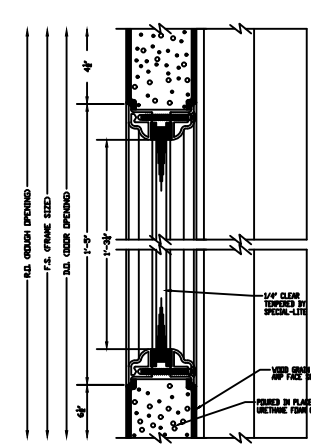

OPTIONAL MID 1/4" GLAZING DETAIL

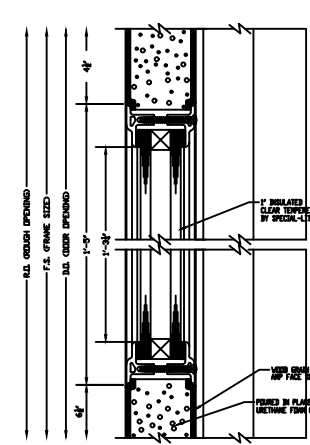

OPTIONAL MID 1" GLAZING DETAIL

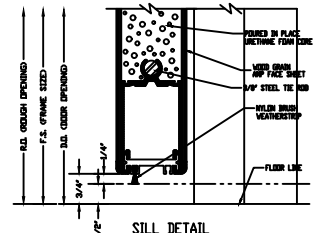

SILL DETAIL

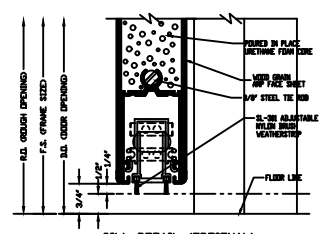

SILL DETAIL (OPTIONAL)

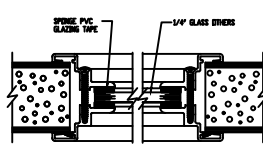

1/4" GLASS VISION LITE KIT DETAIL

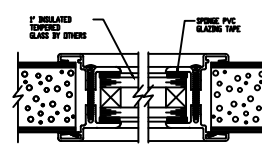

1" INS. GLASS VISION LITE KIT DETAIL

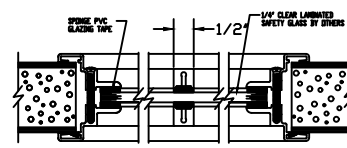

1/4" GLASS VISION LITE KIT DETAIL WITH EXTERNAL MUNTIN

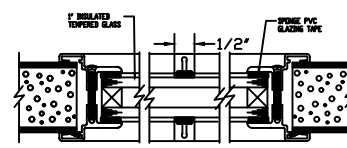

1" INS. GLASS VISION LITE KIT DETAIL WITH EXTERNAL MUNTIN

		SPECIAL-LITE, INC. 860 South Williams Street P.O. BOX 6 DECATUR, MI 48045 WWW.SPECIAL-LITE.COM	
		DRAWN BY: JMM REVISION: A 4/3/17 C B D	SL-18 AMP FLUSH COLONIAL DOOR DATE: 4/3/2017 SHEET NO. 1 OF 1 FILE: SL18DETAILS.dwg