

CONTINUOUS HINGE JAMB DETAIL

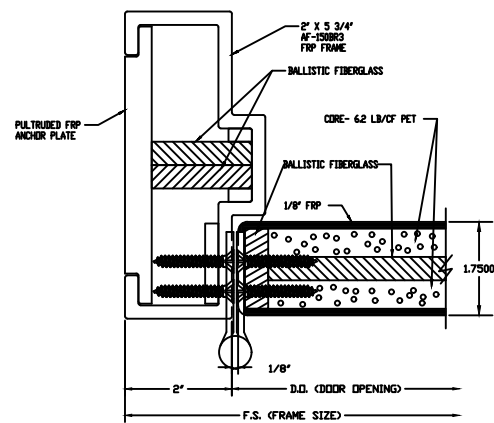

BUTT HINGE JAMB DETAIL

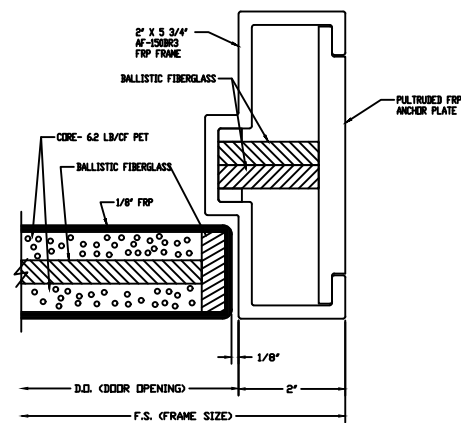

LOCK JAMB DETAIL

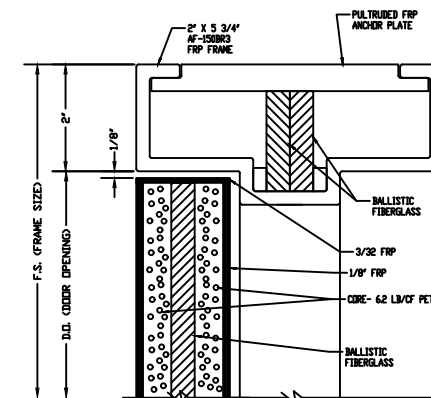

HEAD DETAIL

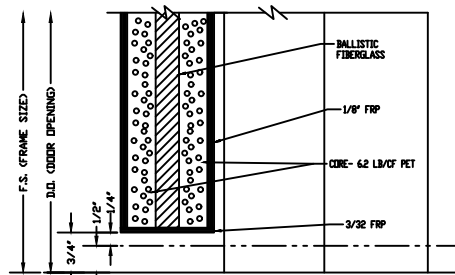

SILL DETAIL

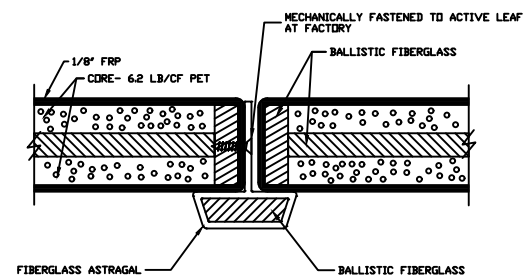

MEETING STILES WITH ASTRAGAL

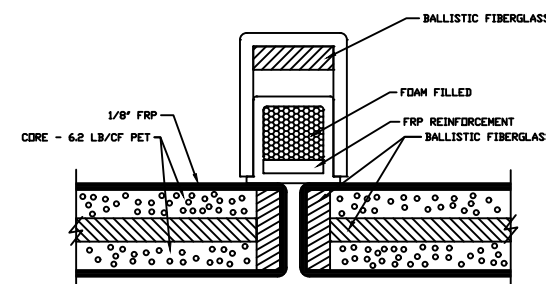

MEETING STILES WITH BALLISTIC MULLION

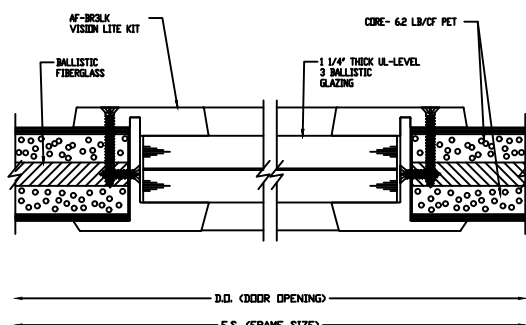

VISION-LITE DETAIL

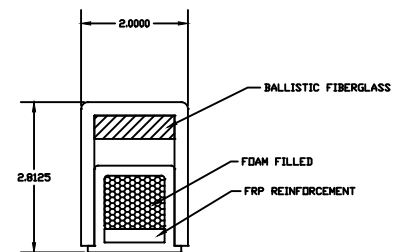

BALLISTIC MULLION DETAIL

		SPECIAL-LITE, INC. 860 South Williams Street P.O. BOX 6 DECATUR, MI 49045 WWW.SPECIAL-LITE.COM	
DRAWN BY: JMM REVISION:		AF-100 BR3 FLUSH DOOR DETAILS	
A 5/4/17 C B 5/30/17 D	DATE: 5/30/2017	SHEET NO. 1 OF 1	FILE: AF100BR3.dwg