

CONTINUOUS HINGE JAMB DETAIL

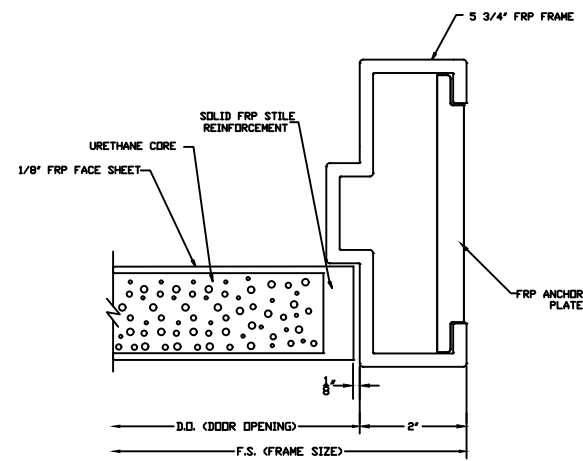

LOCK JAMB DETAIL

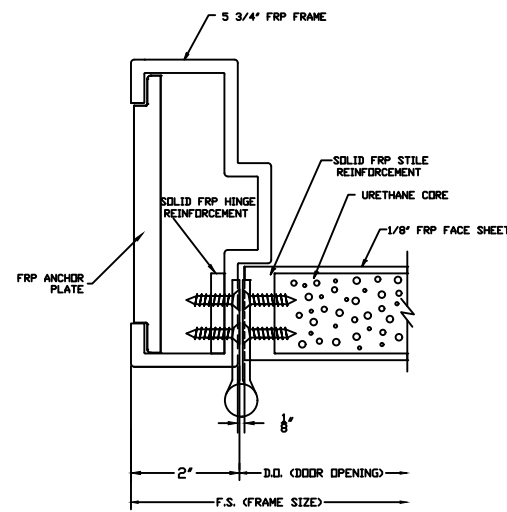

BUTT HINGE JAMB DETAIL

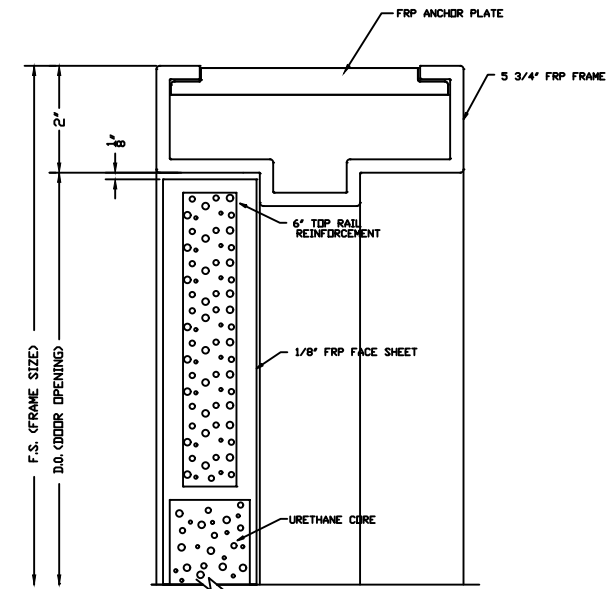

HEAD DETAIL

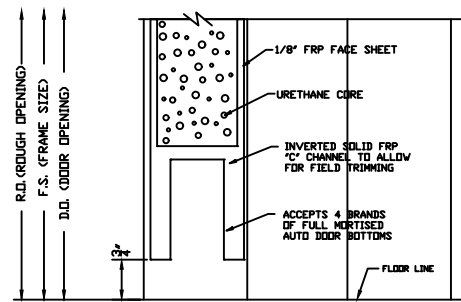

SILL DETAIL

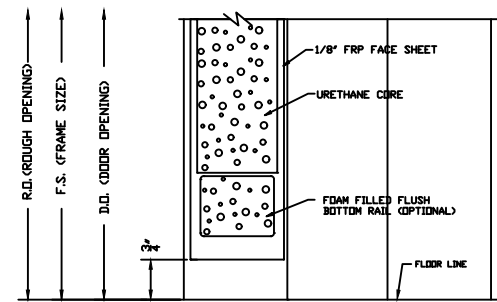

SILL DETAIL (OPTIONAL)

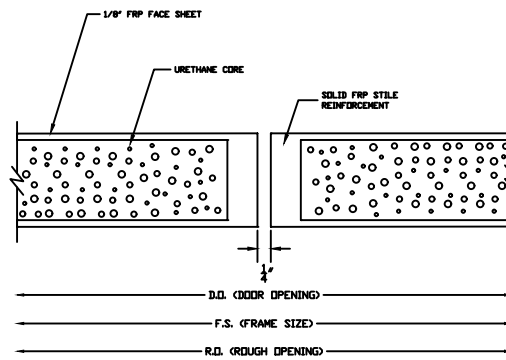

STANDARD MEETING DETAIL

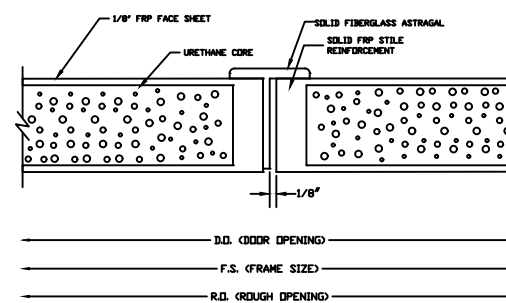

STANDARD MEETING DETAIL WITH OPTIONAL ASTRAGAL

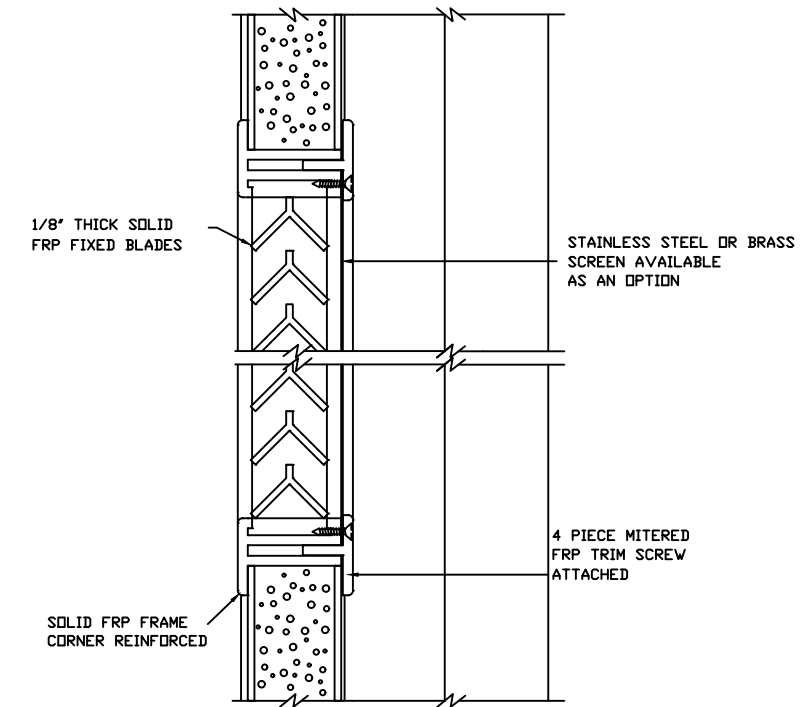

LOUVER WITH INSECT SCREEN DETAIL

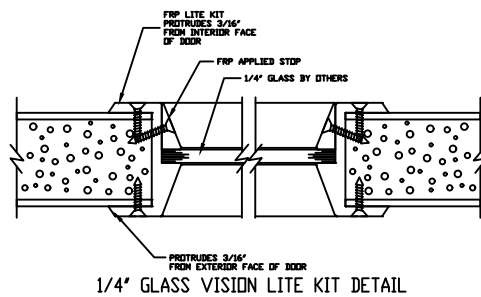

1/4" GLASS VISION LITE KIT DETAIL

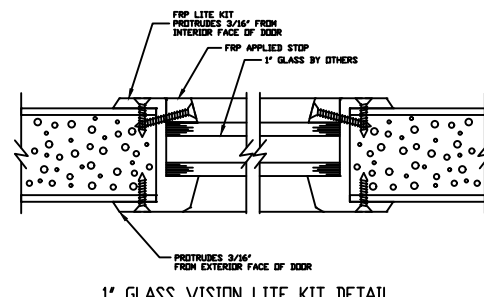

1" GLASS VISION LITE KIT DETAIL

| | | | |
|------------------------|----------------|-------------------------------------------------------------------------------------------------------------------|---------------------------------------------|
| | | SPECIAL-LITE, INC. 860 South Williams Street P.O. BOX 6 DECATUR, MI 49045 WWW.SPECIAL-LITE.COM | |
| | | DRAWN BY: JMM REVISION: | AF-100 ALL FIBERGLASS SMOOTH PULTRUDED DOOR |
| G 12/13/18 H 6/5/18 | DATE: 6/5/2018 | SHEET NO. 1 OF 1 | FILE:AF100DETAILS.dwg |