

DRYWALL ANCHORING (KD Only)

EXISTING OPENING ANCHORING

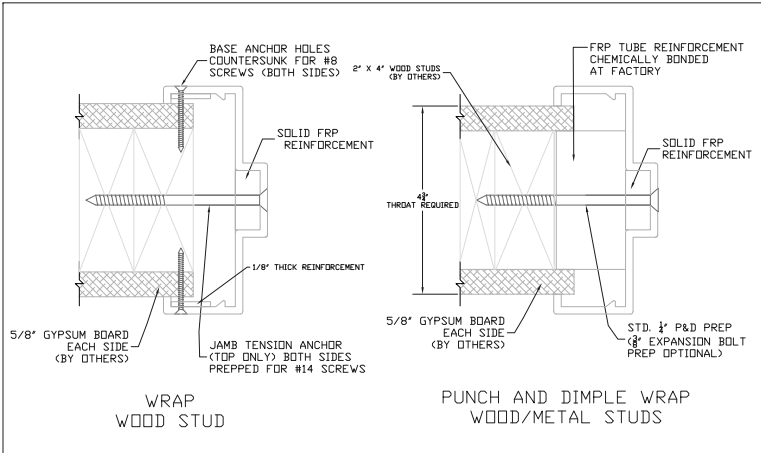

NEW CONSTRUCTION

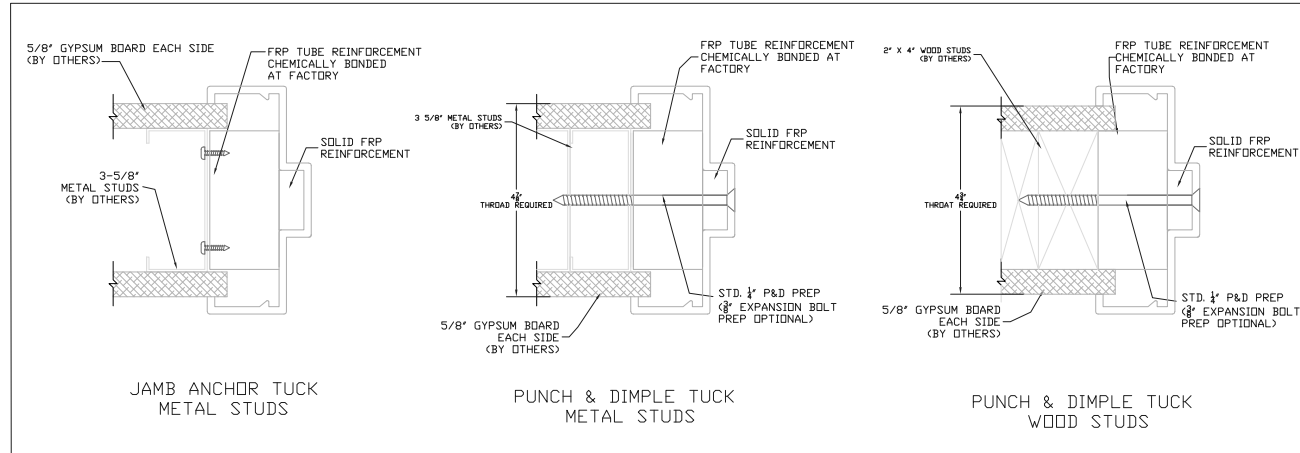

MASONRY ANCHORING (KD Only)

EXISTING OPENING ANCHORING

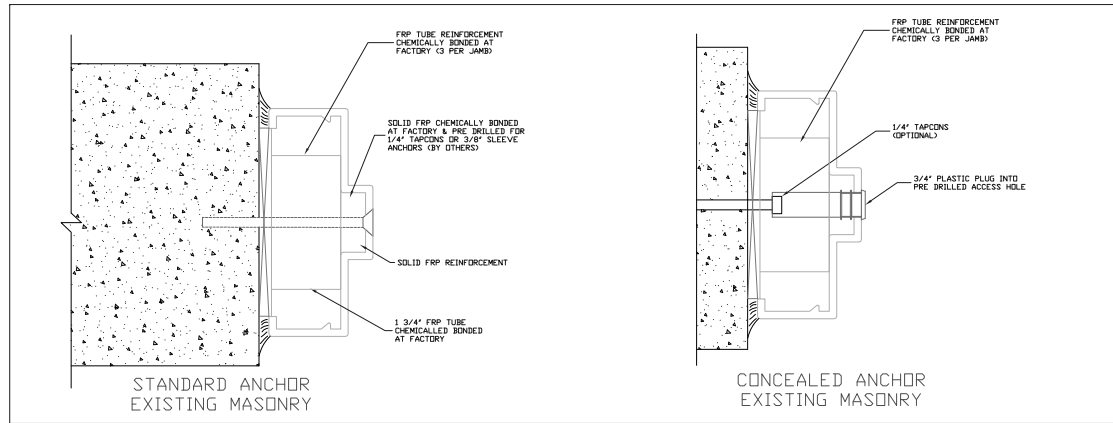

NEW CONSTRUCTION

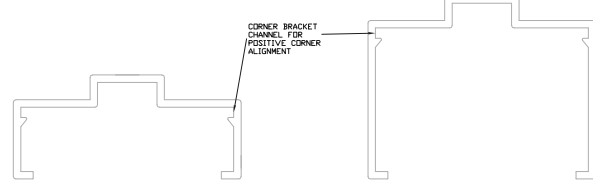
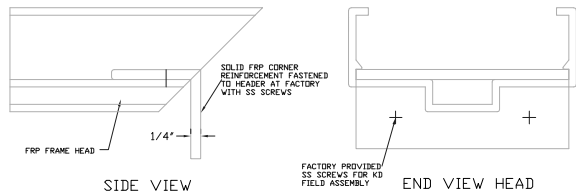
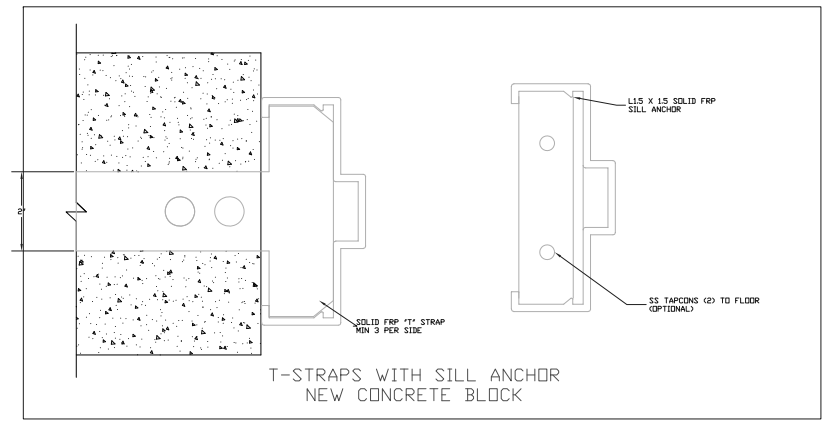

TYP CORNER REINFORCEMENT

2" HEAD STANDARD

4" HEAD OPTIONAL

		SPECIAL-LITE, INC. 860 South Williams Street P.O. BOX 6 DECATUR, MI 49045 WWW.SPECIAL-LITE.COM	
		DRAWN BY: BAS REVISION	AF-250 5 3/4" FRAMING SYSTEM
D 17/12/21 E 15/18/22 E 11/2/21 G 12/20/23		FILE:AF250FRAMING.dwg	

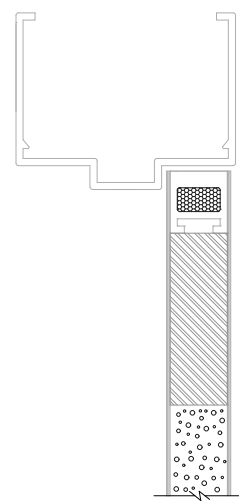
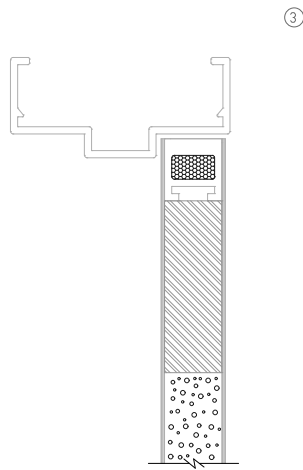
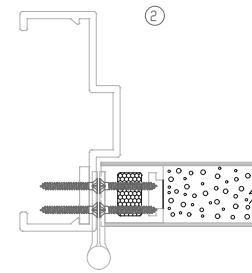
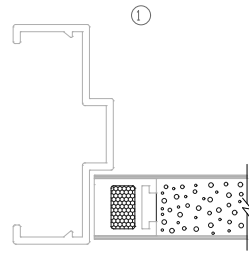
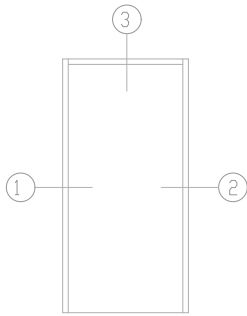

③ OPTIONAL 4" HEADER

		SPECIAL-LITE, INC. 860 South Williams Street P.O. BOX 6 DECATUR, MI 49045 WWW.SPECIAL-LITE.COM	
		AF-250 5 3/4" FRAMING SYSTEM	
DRAWN BY: JMM REVISION:	DATE: 1/7/2020	SHEET NO. 1 OF 2	FILE: AF250FRAMING.dwg