

CONTINUOUS HINGE JAMB DETAIL

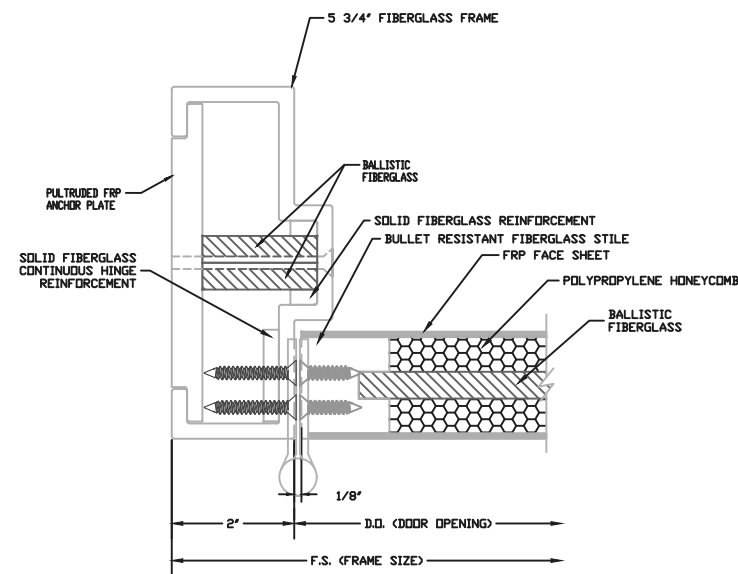

BUTT HINGE JAMB DETAIL

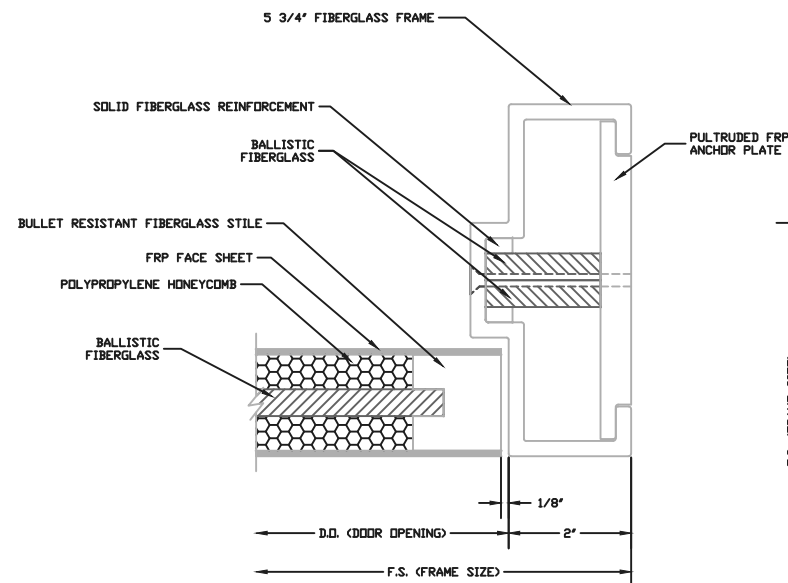

LOCK JAMB DETAIL

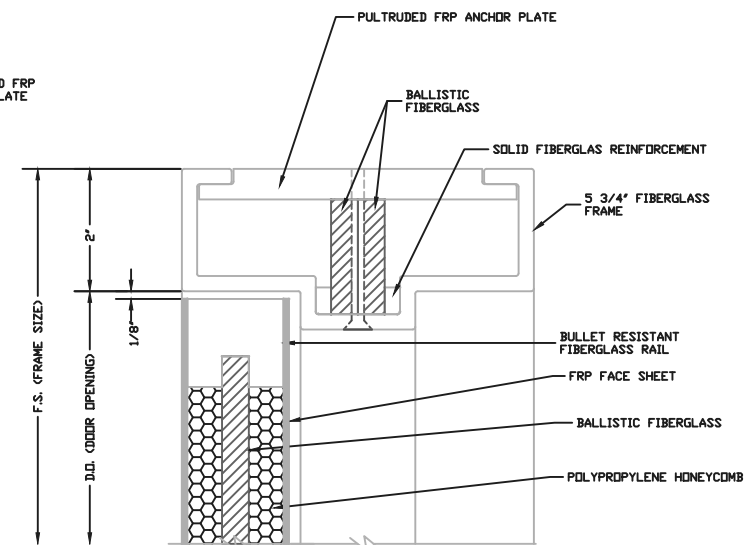

HEAD DETAIL

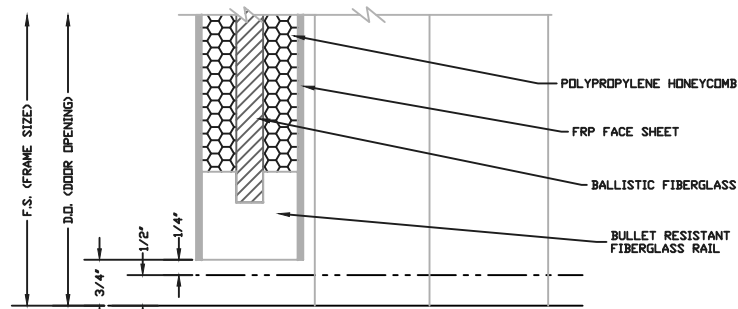

SILL DETAIL

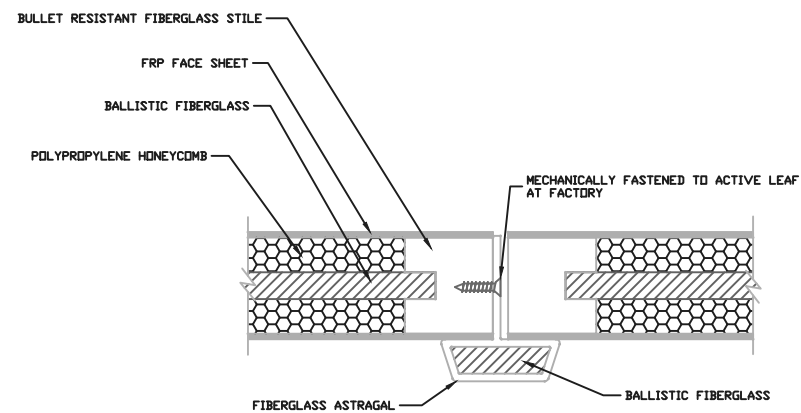

MEETING STILES WITH ASTRAGAL

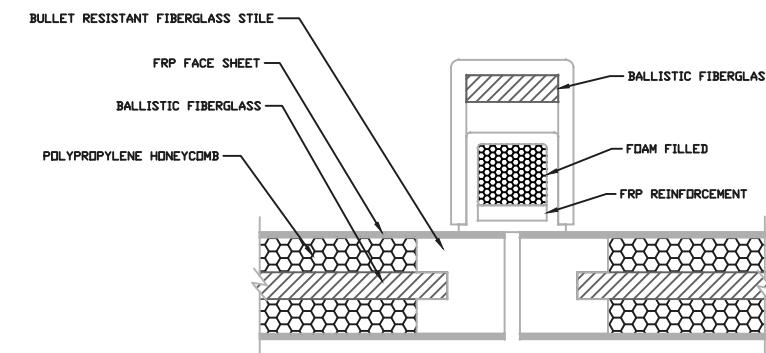

MEETING STILES WITH BALLISTIC MULLION

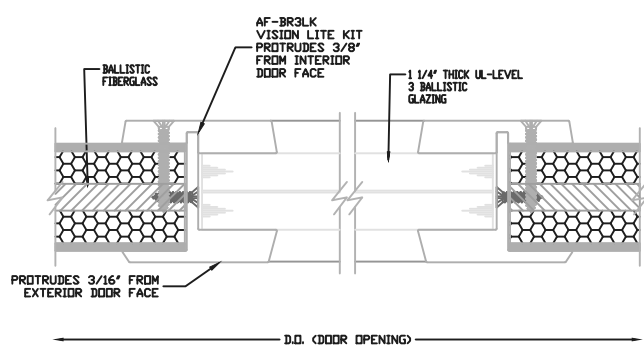

VISION-LITE DETAIL

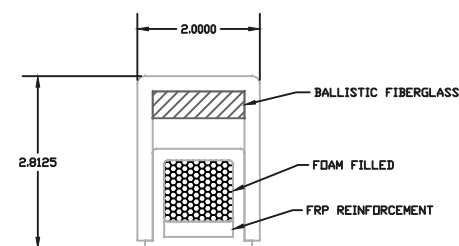

BALLISTIC MULLION DETAIL

AF-200BR3	SMOOTH FRP FACE SHEET
AF-217BR3	PEBBLE GRAIN FRP FACE SHEET
AF-219BR3	RUSTIC WOOD GRAIN FRP FACE SHEET
AF-219-1BR3	CONTEMPORARY WOOD GRAIN FRP FACE SHEET
AF-220BR3	SANDSTONE FRP FACE SHEET

 <p><b>Special-Lite</b> ENGINEERED ARCHITECTURAL SOLUTIONS</p>	<p><b>SPECIAL-LITE, INC.</b> 860 South Williams Street P.O. BOX 6 DECATUR, MI 48045 WWW.SPECIAL-LITE.COM</p>	
	<p>DRAWN BY: JMM REVISION D 2/14/19 F 9/15/21 E 7/12/21 G</p>	<p>AF-COMPOSITE BR3 DOOR DETAILS</p>