

BUTT HINGE JAMB DETAIL
(NOT AVAILABLE ON BEVELED STILE)

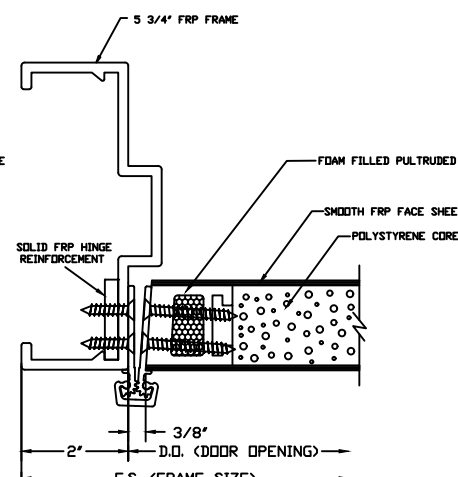

CONTINUOUS HINGE JAMB DETAIL

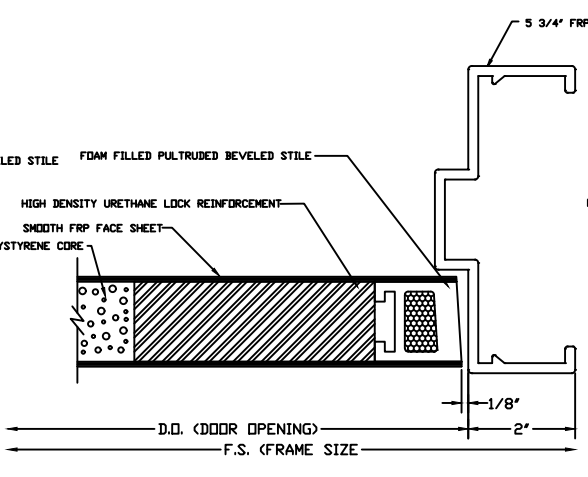

LOCK JAMB DETAIL

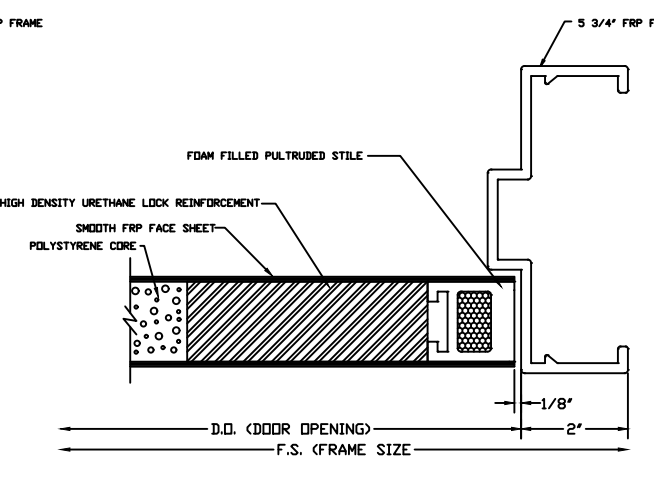

LOCK JAMB DETAIL
(OPTIONAL SQUARE STILE)

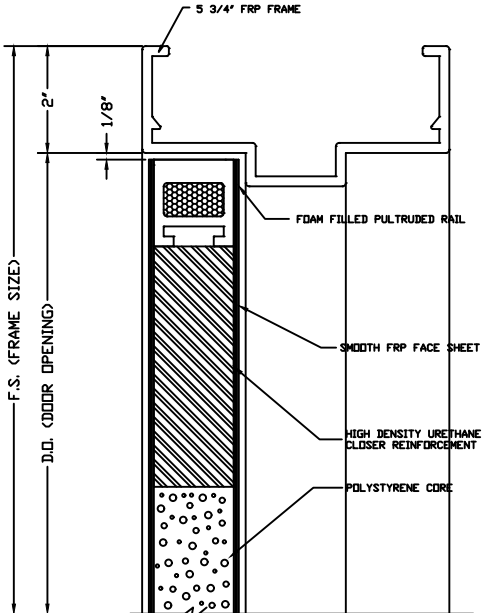

HEAD DETAIL

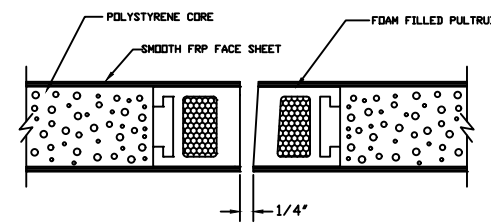

MEETING STILES (STANDARD)

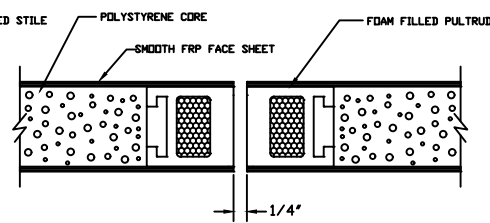

MEETING STILES OPTIONAL SQUARE STILE

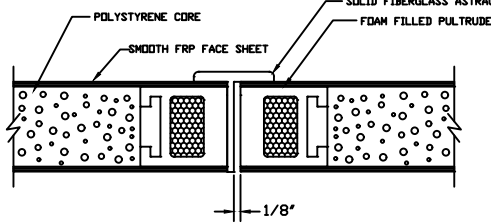

MEETING STILES WITH OPTIONAL ASTRAGAL

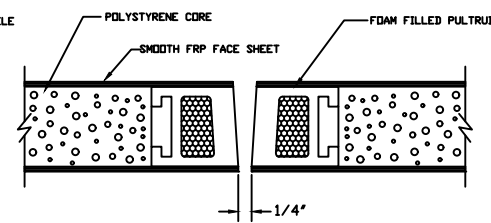

MEETING STILES WITH OPTIONAL DUAL BEVELED STILES

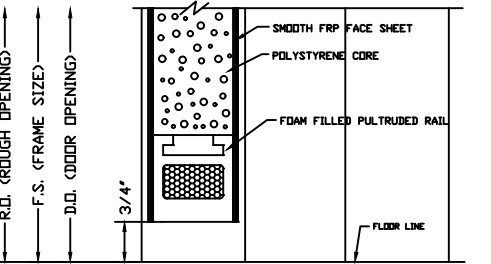

SILL DETAIL (FLUSH BOTTOM)

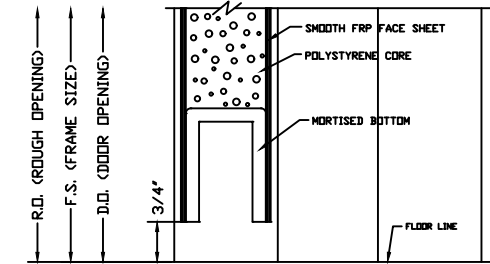

SILL DETAIL (MORTISED BOTTOM)

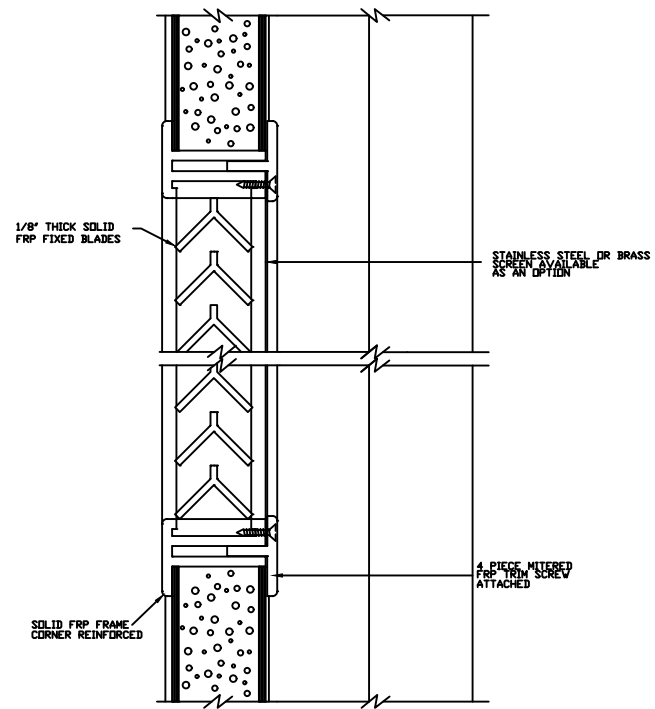

LOUVER WITH INSECT
SCREEN DETAIL

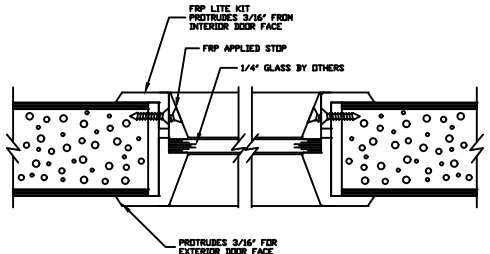

1/4" GLASS VISION LITE KIT DETAIL

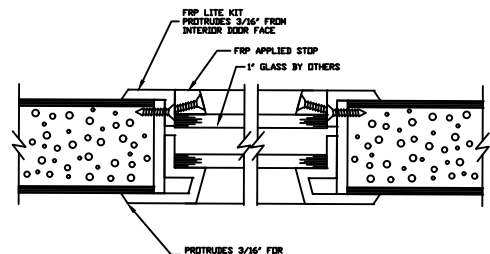

1" GLASS VISION LITE KIT DETAIL

Special-Lite®
ENGINEERED ARCHITECTURAL SOLUTIONS

SPECIAL-LITE, INC.
860 South Williams Street
P.O. BOX 6
DECATUR, MI 48045
WWW.SPECIAL-LITE.COM

DRAWN BY: JMM	AF-200 ALL FIBERGLASS COMPOSITE SMOOTH DOOR		
REVISION	DATE: 8/30/2018	SHEET NO. 1 OF 1	FILE: AF200DETAILS.dwg
M 6/6/18	Q 12/3/18		
N 8/30/18	P		