

BUTT HINGE JAMB DETAIL
(NOT AVAILABLE ON BEVELED STILE)

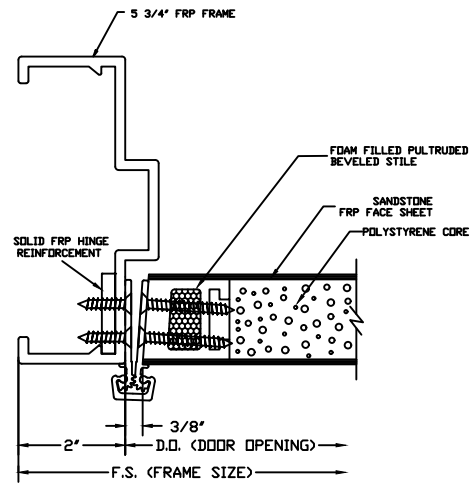

CONTINUOUS HINGE JAMB DETAIL

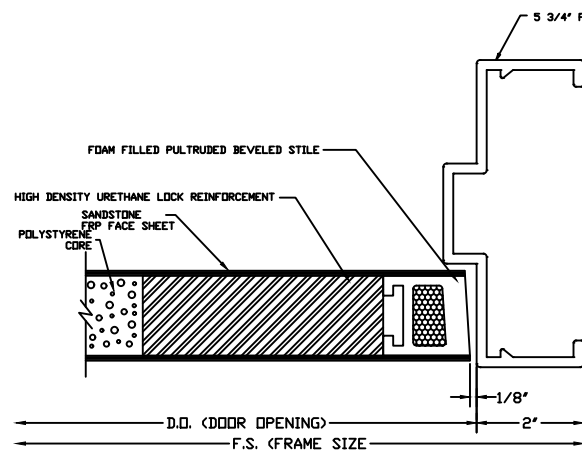

LOCK JAMB DETAIL

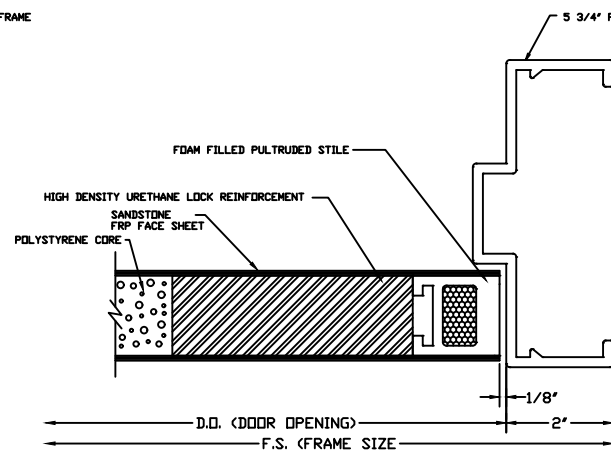

LOCK JAMB DETAIL
(OPTIONAL SQUARE STILE)

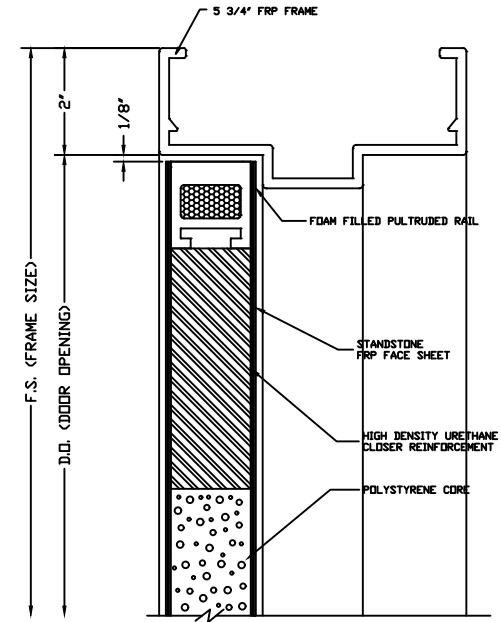

HEAD DETAIL

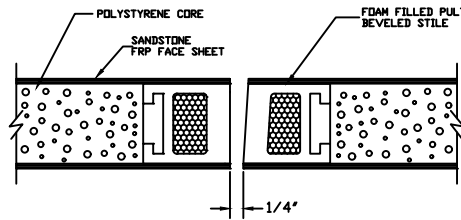

MEETING STILES (STANDARD)

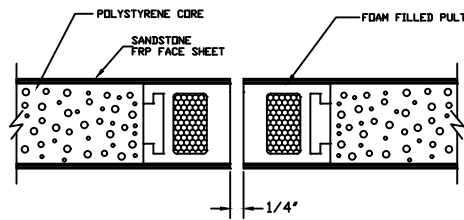

MEETING STILES OPTIONAL SQUARE STILE

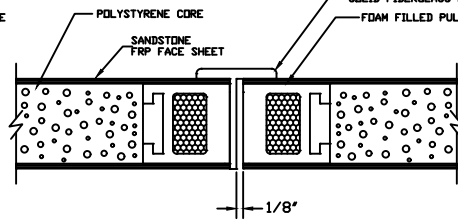

MEETING STILES WITH OPTIONAL ASTRAGAL

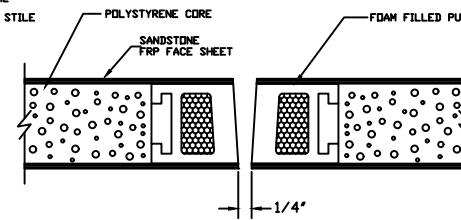

MEETING STILES WITH OPTIONAL DUAL BEVELED STILE

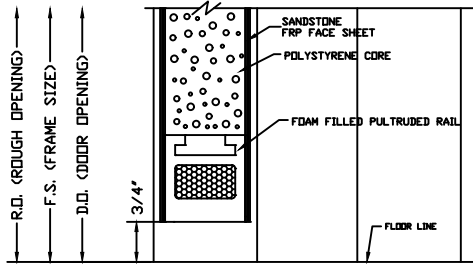

SILL DETAIL (FLUSH BOTTOM)

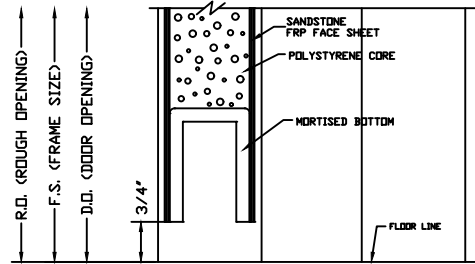

SILL DETAIL (MORTISED BOTTOM)

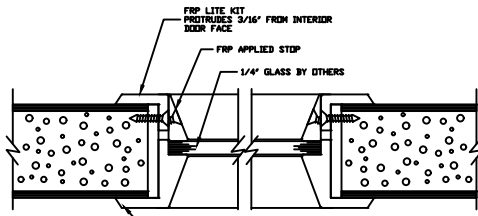

1/4" GLASS VISION LITE KIT DETAIL

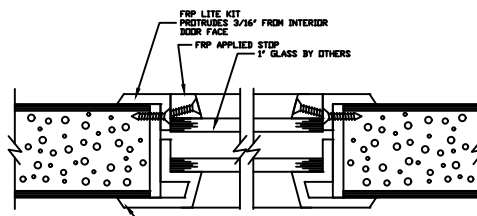

1" GLASS VISION LITE KIT DETAIL

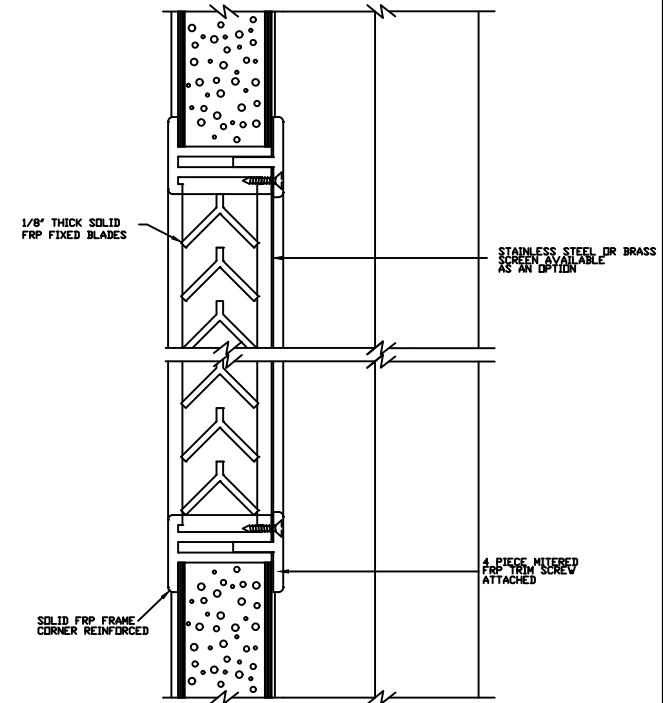

LOUVER WITH INSECT
SCREEN DETAIL

		SPECIAL-LITE, INC. 860 South Williams Street P.O. BOX 6 DECATUR, MI 48045 WWW.SPECIAL-LITE.COM	
DRAWN BY: JMM REVISION:	AF-220 ALL FIBERGLASS COMPOSITE SANDSTONE-TEXTURED DOOR	DATE: 8/30/2018	SHEET NO. 1 OF 1
M 6/6/18 N 8/30/18 P	O 12/3/18	FILE: AF220DETAILS.dwg	